

## Conductivity meter



Type 8222 can be combined with...



**Type 6642**  
Solenoid valve



**Type 8802-DF**  
Diaphragm valve with control unit



**Type 2030**  
On/Off Diaphragm valve

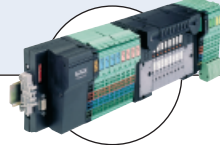

**Type 8644**  
Valve islands



**Type 8620**  
Cooling Tower or boiler chemistry controller

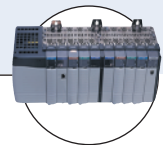

**PLC**

- Configurable outputs: two transistor and single or dual analog 4... 20 mA
- Removable backlighted display
- Universal process connection
- Three cell constants for covering a wide measuring range
- Diagnostic functions

The Bürkert compact meter Type 8222 is designed for measuring the conductivity of fluids.

The conductivity meter consists of a sensor, plugged-in and pinned to an enclosure with cover, containing the electronic module and a removable display. The sensor comprises a cell with two electrodes and a Pt1000 temperature probe. The sensor itself is available with three different cell constants C, these with C=0.01 or 0.1 are fitted with stainless steel electrodes and those with C=1.0 are fitted with graphite electrodes.

The conductivity meter can operate independent of the display but it will be required for programming the device (i.e. selection of sensor cell constant, language, measuring range, engineering units, calibration...) and also for visualizing continuously the measured and processed data.

The device Type 8222 is available:  
- with three fully programmable outputs: two transistor and one 2-wire 4... 20 mA current outputs  
- with four fully programmable outputs: two transistor and two 3-wire 4... 20 mA current outputs.

The electronics of Type 8222 converts the measured signal, displays different values in different physical units (if display mounted) and computes the output signals, which are provided via one or two M12 fixed connectors.

### Technical data (Pipe + conductivity meter)



<b>Pipe diameter</b>	DN25 to DN110 (DN<25 with reduction)
<b>Conductivity measurement</b>	
Measuring range	0.05 µS/cm... 10 mS/cm
Resolution	1 nS/cm
Accuracy	±3% of measured value
<b>Temperature measurement</b>	
Measuring range	-40 to +130°C (-40 to 266°F)
Internal resolution	0.1°C (0.18°F)
Accuracy	±1°C (1.8°F)
Minimal temperature range	10°C (i.e. 10 to 20°C (50 to 68°F) corresponding to 4... 20 mA)
<b>Temperature compensation</b>	none or according to a predefined graph (NaCl or ultra pure water) or according to a graph defined especially for your process
<b>Medium temperature</b>	
with G1½" PVC nut connection	0 to 50°C (32 to 122°F)
with G1½" PVDF nut connection	-20 to 100°C (-4 to 212°F) restricted by the used adaptor restriction with adaptor S022 in: - PVC: 0 to 50°C (32 to 122°F) - PP: 0 to 80°C (32 to 176°F) - Metal: -20 to 100°C (-4 to 212°F)
<b>Fluid pressure max</b>	PN16 (232 PSI) (see Pressure/Temperature chart)
<b>Environment</b>	
<b>Ambient temperature</b>	-10 to +60°C (14 to 140°F) (operating and storage)
<b>Relative humidity</b>	≤ 85%, without condensation

# 8222 ELEMENT

bürkert

Electrical data	
<b>Power supply</b>	
3 outputs meter (2-wire)	14 - 36 V DC, filtered and regulated
4 outputs meter (3-wire)	12 - 36 V DC, filtered and regulated
<b>Current consumption</b> with sensor	≤ 1 A (with the 2 transistors loads)
3 outputs meter (2-wire)	≤ 25 mA (at 14 V DC without transistors load, with current loop)
4 outputs meter (3-wire)	≤ 5 mA (at 12 V DC without transistors load, without current loop)
<b>Reversed polarity of DC</b>	Protected
<b>Voltage peak</b>	Protected
<b>Short circuit</b>	Protected for transistor outputs
<b>Output</b>	
Transistor	configurable as sourcing or sinking (respectively both as PNP or NPN), open collector max. 700 mA, 0.5 A max. per transistor if the 2 transistor outputs are wired output NPN: 0.2 - 36 V DC output PNP: V+ power supply
Current	4... 20 mA programmable as sourcing or sinking,
3 outputs meter (2-wire)	max. loop impedance: 1100 Ω at 36 V DC; 610 Ω at 24 V DC; 180 Ω at 14 V DC
4 outputs meter (3-wire)	configurable in the same mode as transistor: sourcing or sinking, max. loop impedance: 1100 Ω at 36 V DC; 610 Ω at 24 V DC; 100 Ω at 12 V DC
Response time (10% - 90%)	150 ms (standard)

General data	
<b>Compatibility</b>	Any pipe which are fitted out with Bürkert adaptor S022 (see separate data sheet)
<b>Materials</b>	See exploded view, opposite
Housing / cover	Stainless steel 1.4404, PPS / PC
Seals / Screws	EPDM / Stainless steel
Fixed connector mounting plate	Stainless steel 1.4404 (316L)
Fixed connector	Brass nickel plated
Display / navigation key	PC / PBT
Nut	PVC or PVDF
Wetted part materials	
Conductivity sensor	PVDF, stainless steel 1.4571 (316Ti)
Electrode	Stainless steel 1.4571 (316Ti) for cell constant C=0.01 or C=0.1 or graphite for cell constant C=1.0
<b>Temperature sensor</b>	Pt1000 (316Ti) integrated in the sensor
<b>Display (accessories)</b>	Grey dot matrix 128x64 with backlighting
<b>Electrical connections</b>	
3 outputs meter (2-wire)	1x 5-pin M12 male fixed connector,
4 outputs meter (3-wire)	1x 5-pin M12 male + 1x 5-pin M12 female fixed connectors
<b>Connection cable</b>	Shielded cable

Standards, directives and approvals	
<b>Protection class</b>	IP65 and IP67 with M12 cable plug mounted and tightened and cover fully screwed down
<b>Standard and directives</b> 	
EMC	EN 61000-6-2, EN 61000-6-3
Pressure	Complying with article 3 of §3 from 97/23/CE directive.*
Vibration / Shock	EN 60068-2-6 / EN 60068-2-27
<b>Approvals</b>	
UL-Recognized for US and Canada 	61010-1 + CRN/CSA-C22 No.61010-1

## Materials view

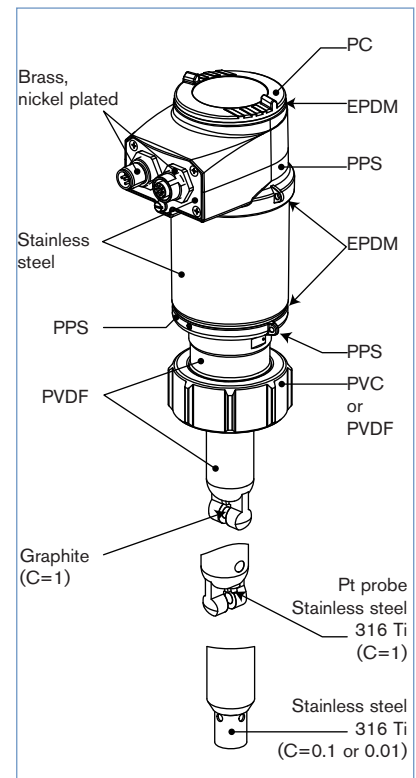

\* For the 97/23/CE pressure directive, the device can only be used under following conditions (depend on max. pressure, pipe diameter and fluid).

Type of fluid	Conditions
Fluid group 1, §1.3.a	Only DN ≤ 25
Fluid group 2, §1.3.a	DN ≤ 32, or DN > 32 and PN*DN ≤ 1000
Fluid group 1, §1.3.b	DN ≤ 25, or DN > 25 and PN*DN ≤ 2000
Fluid group 2, §1.3.b	DN ≤ 125

Pressure/Temperature chart

**Application range of a 8222 ELEMENT conductivity meter:**

- A**: with PVDF nut
- B**: with PVC nut

The measures have been made at an ambient temperature of 60°C.

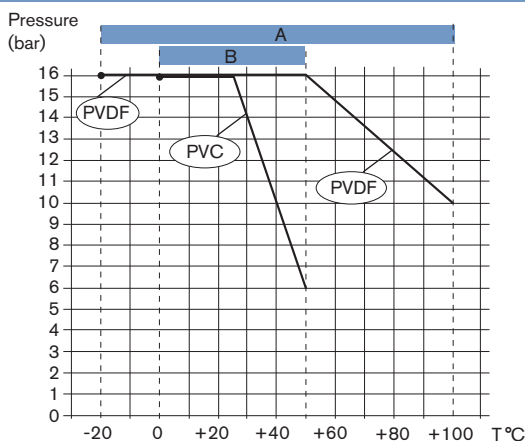

**Application range of a 8222 ELEMENT conductivity meter with PVC nut with S022 adaptor**

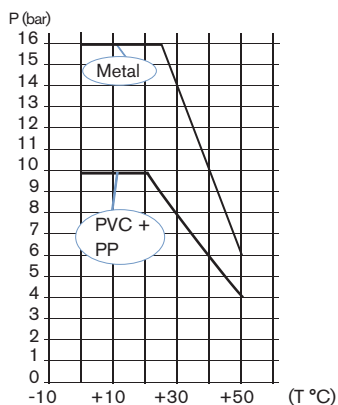

**Application range of a 8222 ELEMENT conductivity meter with PVDF nut with S022 adaptor**

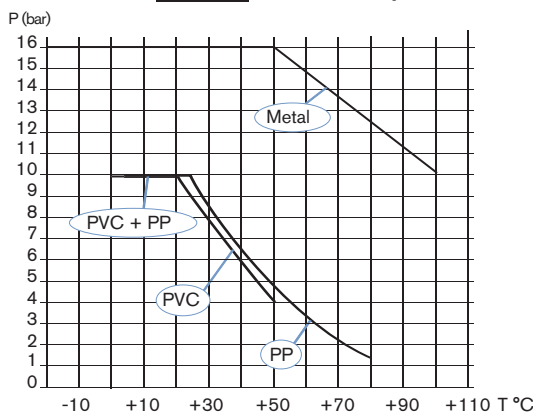

**Principle of operation**

Conductivity is defined as the ability of a solution to conduct electrical current. The load carriers are ions (E.G. dissolved salt or acids). In order to measure conductivity two electrodes are used which are set at a fixed distance apart and with a known specified surface. An AC voltage source is connected to the electrodes. The measured current is a direct function of the conductivity of the solution. The conductivity meter is a two-wire device (single meter version) or a three-wire device (dual meter version) and requires a power supply of 14 V DC (single meter version) or 12 V DC (dual meter version) up to 36 V DC.

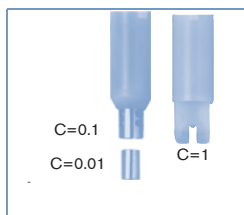

The conductivity meter can be fitted with 3 different sensors with cell constants 0.01, 0.1 or 1.0.

The sensor is selected according to the measuring range and medium by using the table opposite.

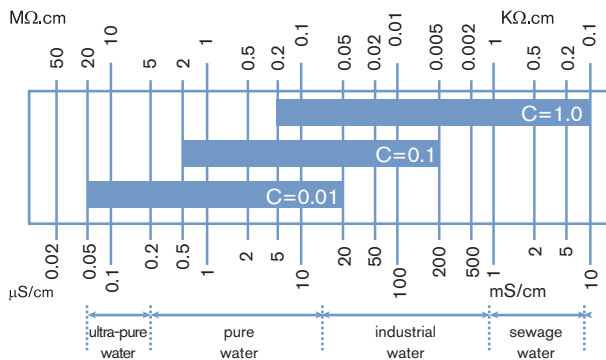

## Installation

The 8222 conductivity meter can be installed into any adaptor with G1½" external threaded sensor connection by just fixing the main nut. Select and install the required adaptor onto the pipe according to specific requirements of the sensor and material (temperature and pressure). For mounting on a tank or direct mounting on a pipe (DN100 and DN110), an adaptor with a G1½" external threaded sensor connection must be used. Install cautiously the device on the fitting. It can be installed in any position (**prefer "A" mounting to install a 8222 with sensor C=0.1 or C=0.01**).

In order to get reliable measurement air bubbles must be avoided.

**Please ensure that the mounting location provides a continuous and complete immersion of the sensor in the flow stream.**

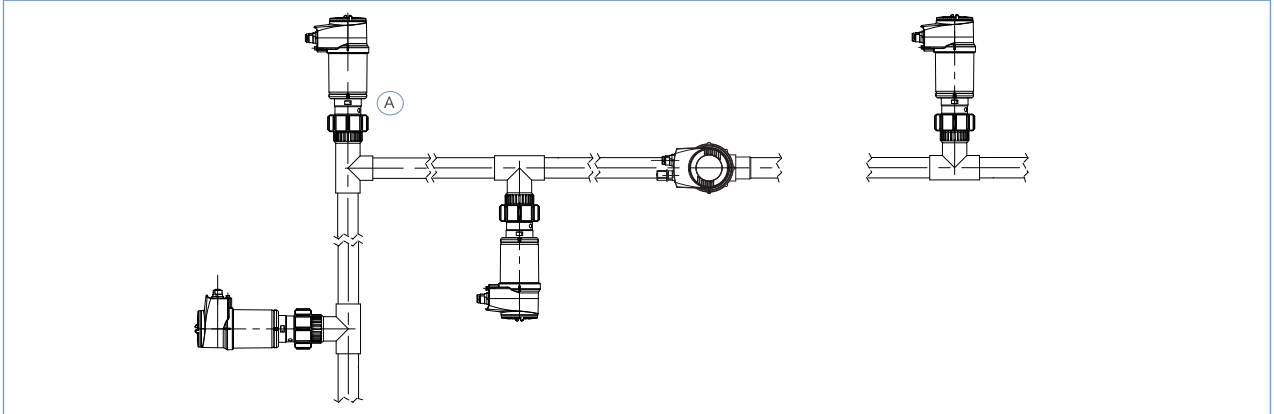

The device must be protected from constant heat radiation and other environmental influences, such as direct exposure to sunlight.

## Dimensions [mm] of conductivity meter Type 8222

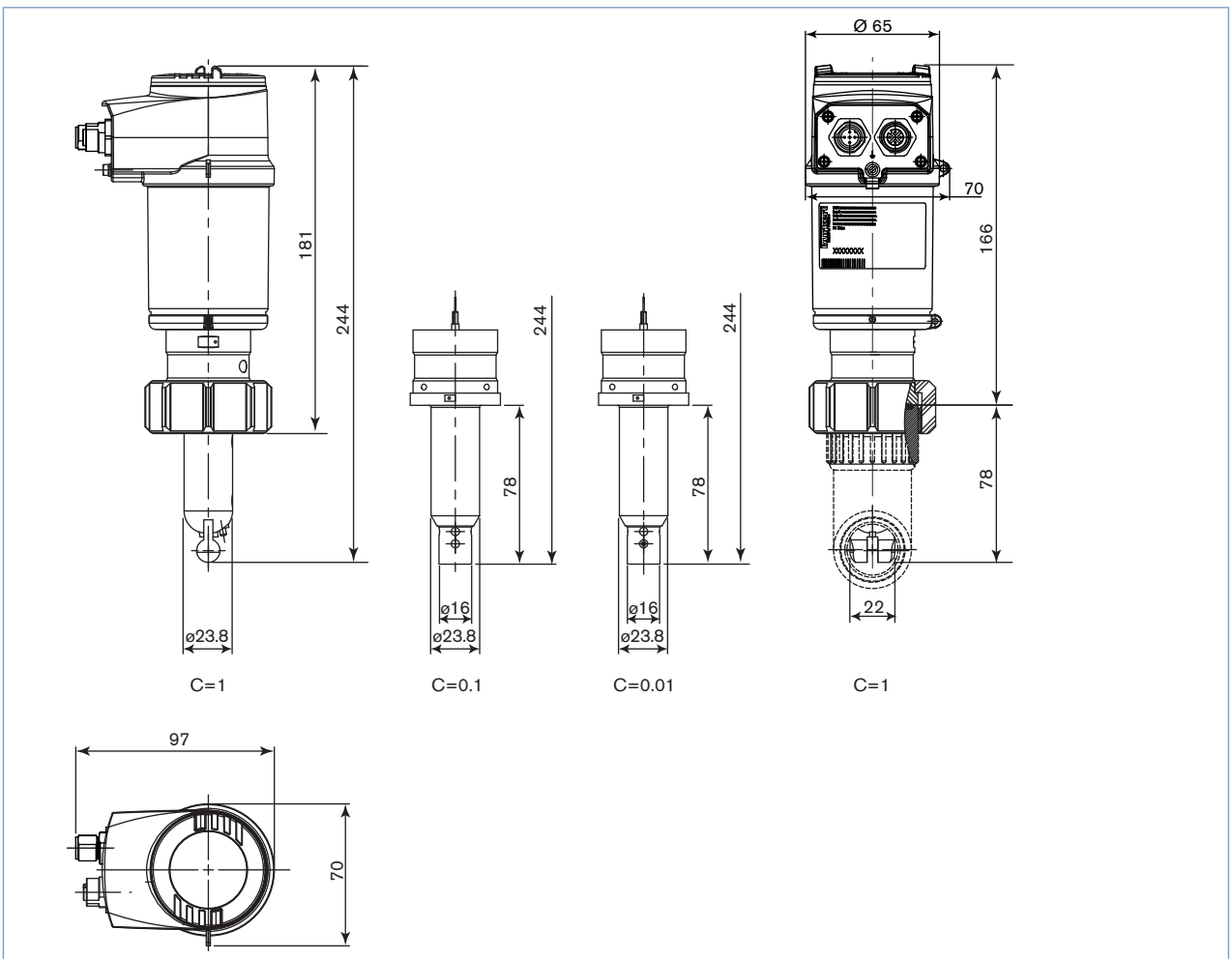

## Ordering information for compact conductivity meter Type 8222

A complete compact ELEMENT conductivity meter Type 8222 consists of a compact ELEMENT conductivity meter Type 8222, a removable display/configuration module and a Bürkert INSERTION adaptor Type S022 (with G1½" external threaded sensor connection).

The following information is necessary for the selection of a complete device:

- **Item no.** of the desired ELEMENT conductivity meter **Type 8222** (see ordering chart on p. 6)
- **Item no.** of the a removable display/configuration module (see accessories ordering chart on p. 7)
- **Item no.** of the selected INSERTION adaptor **Type S022** with G1½" external threaded sensor connection (see separate data sheet)

→ You have to order two or three components.









**Attention!**

When you order devices without display, please take care that you also order at least one display module for the operation.  
Order no. of the removable display/configuration module, see ordering chart on p. 7

When you click on the orange box "More info." below, you will come to our website for the resp. product where you can download the data sheet.

**Example**

<p><b>Compact conductivity meter Type 8222 without display</b></p> 	+	<p><b>Removable display/configuration module</b></p> 
		
		
<p><b>INSERTION adaptor Type S022</b></p>  <div style="display: flex; justify-content: center; align-items: center; margin-top: 5px;">  </div>		













**Complete ELEMENT device for conductivity measurement Type 8222**



Fitting (example only)

Ordering chart for compact conductivity meter Type 8222

Conductivity meter Type 8222





Specifications	Voltage supply	Output	Sensor version	Nut material	Electrical connection	UL Approvals	Item no.
Compact conductivity meter without display	14 - 36 V DC	2 x transistors + 1 x 4... 20 mA	C=0.01	PVC	5-pin M12 male fixed connector	No	559 618
						 UL-Recognized	562 394
				PVDF	5-pin M12 male fixed connector	No	559 620
						 UL-Recognized	562 396
			C=0.1	PVC	5-pin M12 male fixed connector	No	559 614
						 UL-Recognized	559 624
			PVDF	5-pin M12 male fixed connector	No	559 616	
					 UL-Recognized	559 626	
	C=1.0	PVC	5-pin M12 male fixed connector	No	559 610		
				 UL-Recognized	559 638		
		PVDF	5-pin M12 male fixed connector	No	559 612		
				 UL-Recognized	559 622		
	12 - 36 V DC	2 x transistors + 2 x 4... 20 mA	C=0.01	PVC	5-pin M12 male and 5-pin M12 female fixed connectors	No	559 619
						 UL-Recognized	562 395
				PVDF	5-pin M12 male and 5-pin M12 female fixed connectors	No	559 621
						 UL-Recognized	562 397
C=0.1			PVC	5-pin M12 male and 5-pin M12 female fixed connectors	No	559 615	
					 UL-Recognized	559 625	
PVDF			5-pin M12 male and 5-pin M12 female fixed connectors	No	559 617		
				 UL-Recognized	559 627		
C=1.0	PVC	5-pin M12 male and 5-pin M12 female fixed connectors	No	559 611			
			 UL-Recognized	559 639			
PVDF	5-pin M12 male and 5-pin M12 female fixed connectors	No	559 613				
		 UL-Recognized	559 623				

**Note: Order separately** (see accessories)

- display/configuration module

- M12 cable plugs (only female for 1 x 4... 20 mA, 1 male + 1 female for 2 x 4... 20 mA conductivity meter)

Ordering chart for accessories

Description		Item no.
Removable display/configuration module (with instruction sheet)		559 168
Black blank cover with EPDM seal		560 948
Transparent cover with EPDM seal		561 843
Calibration solution, 300 ml, 5 µS		440 015
Calibration solution, 300 ml, 15 µS		440 016
Calibration solution, 300 ml, 100 µS		440 017
Calibration solution, 300 ml, 706 µS		440 018
Calibration solution, 300 ml, 1413 µS		440 019
	5-pin M12 female straight cable plug with plastic threaded locking ring, to be wired	917 116
	5-pin M12 male straight cable plug with plastic threaded locking ring, to be wired	560 946
	5-pin M12 female straight cable plug moulded on cable (2 m, shielded)	438 680
	5-pin M12 male straight cable plug moulded on cable (2 m, shielded)	559 177

Interconnection possibilities with other Bürkert devices

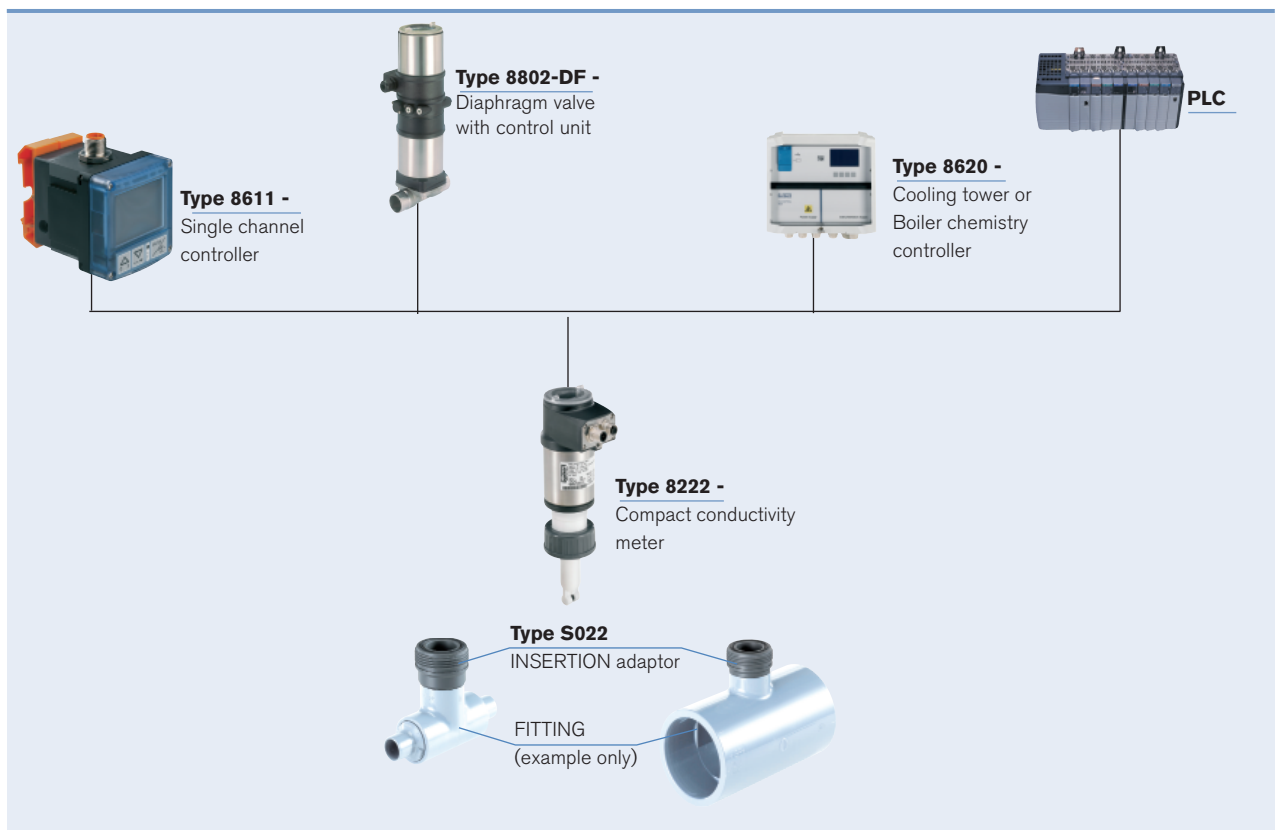

To find your nearest Bürkert office, click on the orange box →

[www.burkert.com](http://www.burkert.com)

In case of special application conditions,  
please consult for advice.

Subject to alteration.  
© Christian Bürkert GmbH & Co. KG

1412/7\_EU-en\_00895068

DTS 1000114221 EN Version: H Status: RL (released | freigegeben | valide) printed: 04.12.2014