

Digital inductive conductivity transmitter



- Optimal solution for conductivity measurements in difficult fluids (polluted, dirty,...)
- PEEK/PPA version for CIP applications
- Large range of process connections with various fittings
- Multi language, menu-guided operation

Type 8226 can be combined with...



Type S020

INSERTION fitting



Type 6642

Solenoid valve



Type 2731

Diaphragm valve for continuous control



Type 2030

On/Off Diaphragm valve

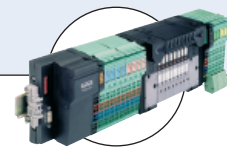

Type 8644

Valve islands

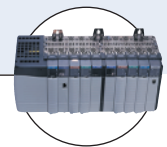

PLC

The conductivity transmitter Type 8226 combines a conductivity sensor and an electronic module with a display in an IP65 enclosure. The sensor component consists of a pair of magnetic coils in a PP, PVDF or PEEK housing. The cell constant is an average value over the whole measuring range. It can be re-adjusted depending on application.

The integrated temperature probe for automatic compensation is a standard feature in the conductivity sensor housing.

The transducer component converts the measured signal and displays the actual value. The conductivity transmitter can be installed into pipe by using INSERTION fitting Type S020 available in stainless steel, brass or plastics.

General data	
Compatibility	with fittings S020 (see corresponding data sheet)
Materials	Housing, cover, lid, nut Front panel foil / Screws Cable plug / gland Wetted parts materials Fitting Sensor holder / Seal
Display	15 x 60 mm, 8-digit LCD, alphanumeric, 15 segments, 9 mm high
Electrical connections	Cable plug acc. to EN 175301-803 or cable glands M20 x 1.5
Connection cable	shielded cable with 1.5 mm ² max. cross-section
Complete device data (fitting + Electronics)	
Pipe diameter	DN15 to DN200
Conductivity measurement	Measurement type Measuring range Accuracy
Temperature measurement	Measurement type Accuracy
Temperature compensation	automatic (with standardized integrated temperature sensor) - reference temperature 25°C (77°F)
Medium temperature max.	with fitting in PVC: 5 to 50°C (41 to 122°F), - PP: 5 to 80°C (41 to 176°F) PVDF: -15 to 100°C (5 to 212°F) - stainless steel, brass: -15 to 120°C (5 to 248°F)
Medium pressure max.	PN6 (see pressure/temperature chart)

Electrical data	
Power supply	12-30 V DC (regulated and filtered $\pm 5\%$) or 115/230 V AC
Current consumption with sensor	
Transmitter with relays	12 V DC-supply: 150 mA - 24 V DC-supply: 90 mA 115/230 V AC-supply: 150 mA
Transmitter without relay	12 V DC-supply: 70 mA - 24 V DC-supply: 60 mA 115/230 V AC-supply: 150 mA
Output	4-20 mA programmable, proportional to conductivity or temperature max. load: 1000 Ω at 30 V DC; 800 Ω at 24 V DC; 450 Ω at 15 V DC; 330 Ω at 12 V DC; 2 relays, freely programmable, 3 A, 230 V AC
Environment	
Ambient temperature	0 to +60°C (32 to 140°F) (Operation and storage)
Relative humidity	$\leq 80\%$, without condensation
Standards, directives and approvals	
Protection class	IP65 with cable plug or cable gland mounted and tightened, blanked if not used
Standard and directives	
EMC	EN 50081-2 (1993), EN 50082-2 (1995)
Security	EN 61010-1 (1995)
Pressure	Complying with article 3 of §3 from 97/23/CE directive.*
Vibration	EN 60068-2-6
Shock	EN 60068-2-27

Pressure/temperature chart

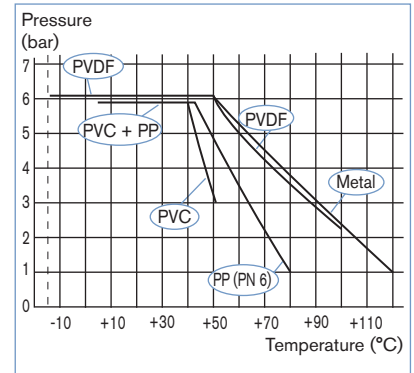

* For the 97/23/CE pressure directive, the device can only be used under following conditions (depend on max. pressure, pipe diameter and fluid).

Type of fluid	Conditions
Fluid group 1, §1.3.a	Forbidden
Fluid group 2, §1.3.a	DN ≤ 100
Fluid group 1, §1.3.b	DN ≤ 100
Fluid group 2, §1.3.b	DN ≤ 100

Operation and display

Customized adjustments, such as measuring range, engineering units and alarm setpoints can be carried out menu-supported on site via a multi-lingual display. The operation is classified according to three levels.

Main Menu

- conductivity
- temperature
- output current
- HOLD function

Calibration Menu

- language
- engineering units
- cell constant
- temperature compensation
- measuring range 4-20 mA
- relay function
- filter selection

Test Menu

- Offset
- Span
- Temperature correction
- conductivity no compensated
- simulation of conductivity
- calibration of the zero point

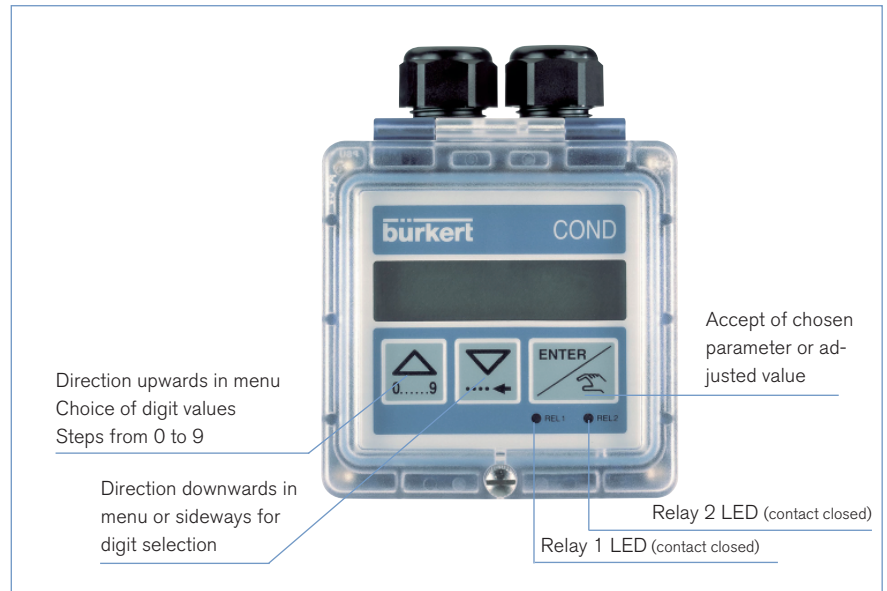

Principle of operation

The conductivity is defined as the ability of a solution to conduct electrical current. The load carriers are ions (E.G. dissolved salt or acids). In order to measure conductivity, an AC voltage source is connected to the primary magnetic coil. The magnetic field induced generates a current in the secondary magnetic coil. The intensity of this induced current is a direct function of the conductivity of the solution.

A 4-20 mA standard signal is available as output signal, proportional to the conductivity or the temperature of the fluid. The transmitter is available, in option, with 2 relays.



The transmitter without relay or with 2 additional relays (limits values freely adjustable) functions in a three wire circuit and requires a power supply of 12-30 V DC. The device is available with an integrated power supply of 115/230 V AC.

Installation

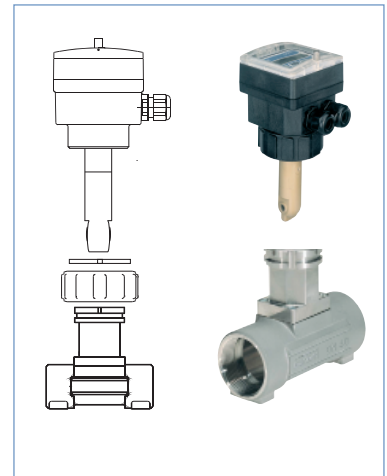
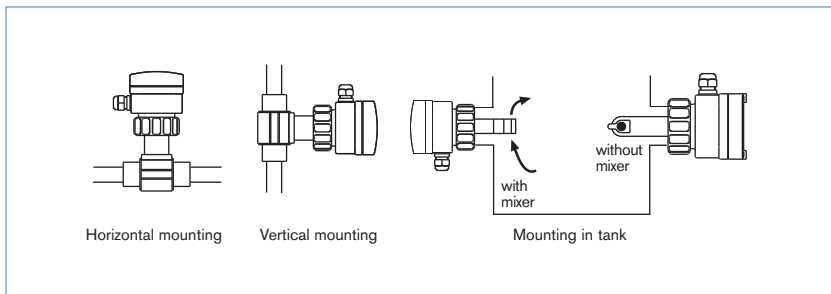
The 8226 conductivity transmitter can be installed into any Bürkert INSERTION fitting (S020). Select and install the required fitting onto the pipe, according to specific requirements of the sensor and fitting material (temperature and pressure). Then, cautiously install the unit on the fitting, and tighten with the nut. The transmitter can be installed in any position. In order to get a reliable measurement, air bubbles must be avoided. The transmitter must be protected from constant heat radiation and other environmental influences, such as direct exposure to sunlight.



Combining the conductivity transmitter Type 8226 with fittings Type S020

Available fitting DN	T-fitting S020 	DN15	DN65	
	Welding tab S020 		DN50	DN200
	Fusion spigot S020 		DN65	DN100
Conductivity measurement 8226		DN15	DN32	DN200

Note A: Use only with analyse plastic fitting version with true union acc. to DIN 8063 (PVC), to DIN 16962 (PP) or to ISO 10931 (PVDF).

Dimensions [mm]

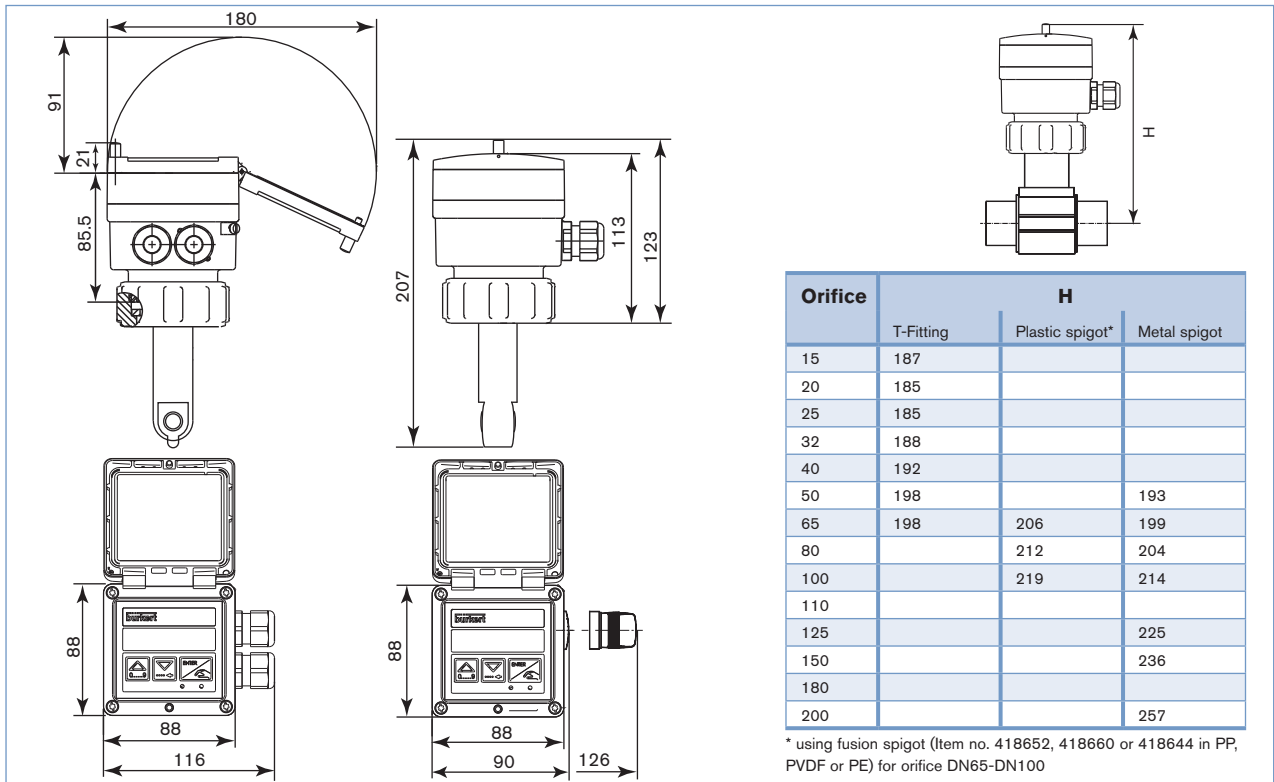

Ordering chart for compact conductivity transmitter Type 8226

A complete compact conductivity transmitter Type 8226 consists of a compact conductivity transmitter Type 8226 and a Bürkert INSERTION fitting Type S020.

The following information is necessary for the selection of a complete device:

- Item no. of the desired conductivity transmitter **Type 8226** (see ordering chart, below)
- Item no. of the selected INSERTION fitting **Type S020** (DN15 - DN200) (see separate data sheet)

More info. When you click on the orange box "More info.", you will come to our website for the resp. product where you can download the data sheet.

→ You have to order two components.

Compact conductivity transmitter Type 8226

Specifications	Voltage supply	Output	Relays	Electrode holder version	Seal	Electrical connection	Item no.			
Compact ¹⁾	12-30 V DC	4-20 mA	None	PP	FKM	EN 175301-803	558 768			
						2 cable glands	558 769			
						PVDF	FKM	EN 175301-803	431 673	
				2 cable glands	431 674					
				PEEK	EPDM	EN 175301-803	440 321			
				2 cable glands	440 322					
	115/230 V AC	4-20 mA	None	2	PP	FKM	2 cable glands	558 770		
							PVDF	FKM	2 cable glands	431 679
							PEEK	EPDM	2 cable glands	440 324
				None	PP	FKM	2 cable glands	558 771		
							PVDF	FKM	2 cable glands	431 677
							PEEK	EPDM	2 cable glands	440 323
2	PP	FKM	2 cable glands	558 772						
			PVDF	FKM	2 cable glands	431 681				
			PEEK	EPDM	2 cable glands	440 325				

¹⁾ 1 Kit including a black EPDM gasket for the sensor, an obturator for an M20 x 1.5 cable gland, a 2 x 6 mm multiway seal and a mounting instruction sheet is supplied with each transmitter with cable glands or 1 Kit including a green FKM and a black EPDM gaskets is supplied with each transmitter with connection EN175301-803.

Ordering chart for accessories for conductivity transmitter Type 8226

Description	Item no.
Set with 2 cable glands M20 x 1.5 + 2 neoprene flat seals for cable gland or plug + 2 screw-plugs M20 x 1.5 + 2 multiway seals 2 x 6 mm	449 755
Set with 2 reductions M20 x 1.5 / NPT1/2" + 2 neoprene flat seals for cable gland or plug + 2 screw-plugs M20 x 1.5	551 782
Set with 1 stopper for unused cable gland M20 x 1.5 + 1 multiway seal 2 x 6 mm for cable gland + 1 black EPDM gasket for the sensor + 1 mounting instruction sheet	551 775
Set with 1 green FKM + 1 black EPDM gaskets	552 111
Ring	619 205
PC - nut	619 204
Cable plug EN 175301-803 with cable gland (Type 2508)	438 811
Cable plug EN 175301-803 with NPT1/2" reduction (Type 2509) - UR and UL approval	162 673
Factory 2-point conductivity calibration certificate	550 675

Interconnection possibilities with other Bürkert devices

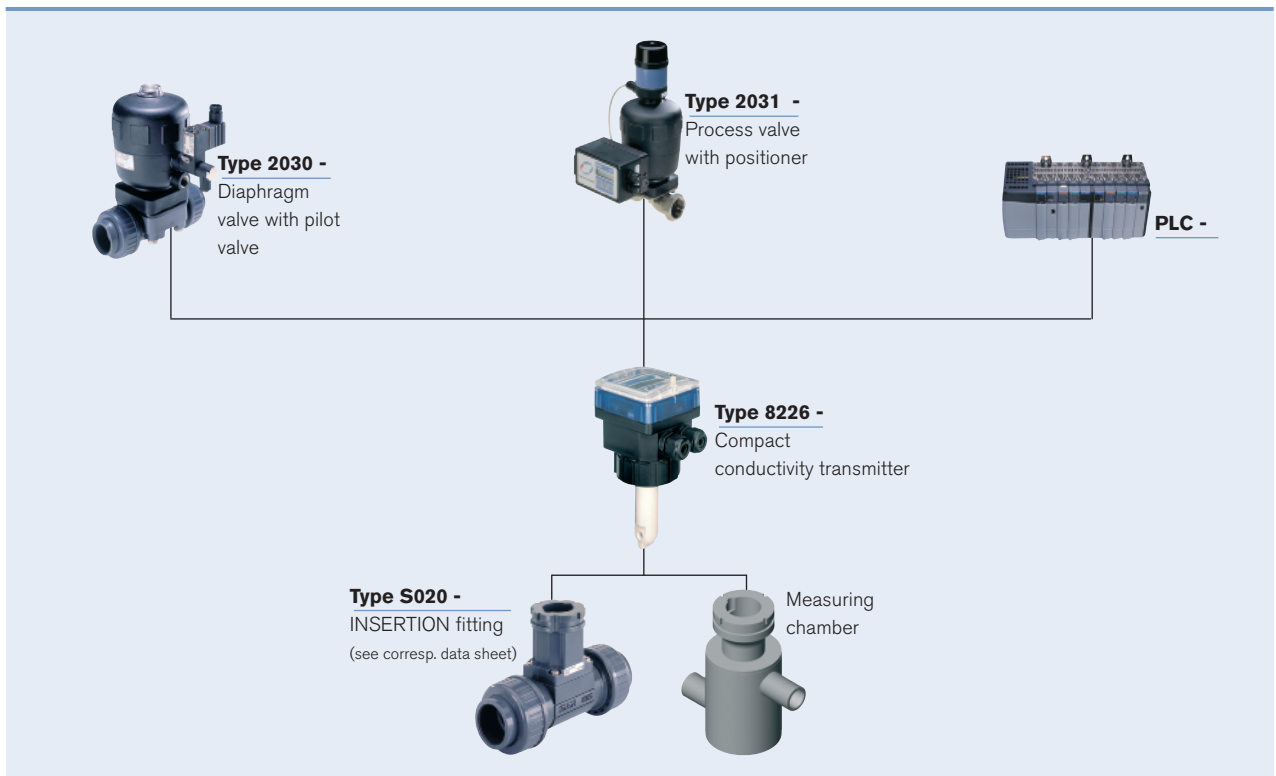

To find your nearest Bürkert facility, click on the orange box →

www.burkert.comIn case of special application conditions,
please consult for advice.Subject to alteration.
© Christian Bürkert GmbH & Co. KG

1203/5_EU-en_00891804